

How the Humble Stereomicroscope Found its Way into Modern Surgery: The Zeiss Operating Microscope

Fritz Schulze 2012

The Operating Microscope - Part 2

1. The Opmi 2
2. Motorized Floor Stand and Ceiling Mount
3. The Opmi 6 and 6S
4. The Opmi 7
5. The Stereo Beam Splitter
6. The Opmi 8
7. The Opmi 9
8. Assistant's Microscopes
9. The New Floor Stands Universal 2 and 3
10. The Opmi 99
11. Outlook

The Opmi 2

A great step forward was the introduction by Carl Zeiss of the first motorized zoom operating microscope, the Opmi 2, in 1966 (Fig.40). It represented the beginning of the hands-free manipulation of the surgical microscope. The surgeon could now concentrate fully on his work..

The body of the Opmi 2 was a cylinder of 130mm diameter and equal length. Its rather bulky size was determined by the two bilateral internal coaxial light sources of 6V 18W each, one version having switchable green filters, another focusable collectors (Fig.39). The motorized zoom range of 1:5 had the factors 0.5 – 2.5, indicated in an illuminated window. The general design followed the Opmi series in so far as virtually all available accessories could also be used on the Opmi 2: binocular tubes, objectives, beam splitter, various external illuminators etc.

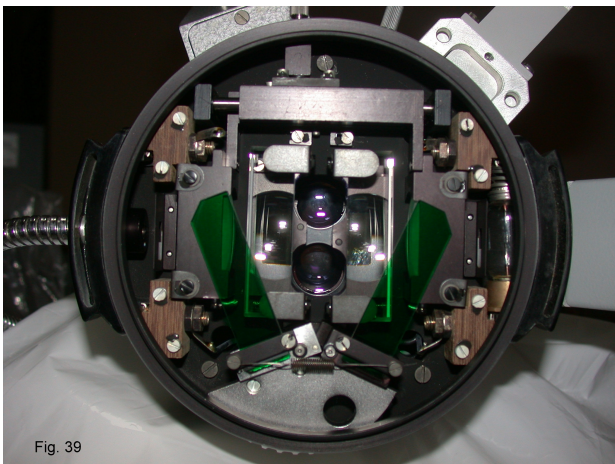

Fig. 39

View of Opmi 2 optics from below.
Right: lamp socket with 6V 18W double end bulb
Left: lamp socket modified to take fibre guide. The two objectives of the Galilean system are clearly visible with the green filters swung out. Besides the objectives the small prisms for the coaxial illumination. This part of the microscope body was covered by a large circular disk with the main objective.

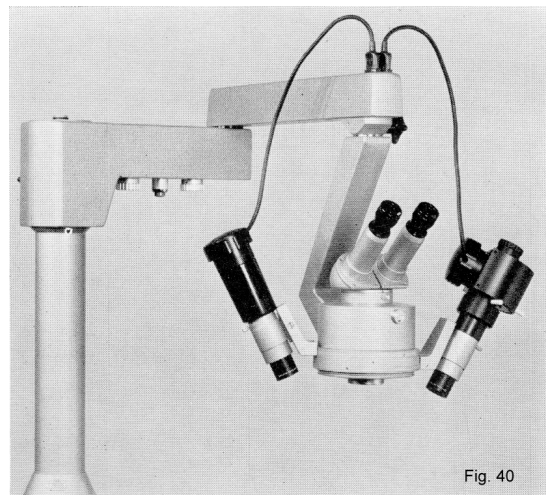

Fig. 40

Opmi 2 with vertical suspension for ophthalmic surgery.
Left: homogeneous illuminator, right: slit lamp.

The Opmi 2 came with a dedicated motorized floor stand with double-jointed arm (Fig. 42). All cables necessary for the motorized functions and coaxial illuminators were accommodated inside the arms. For increased versatility, a vertical hand-cranked extension, adding 390mm in height, could be installed.

Depending on the intended surgery, three models of the Opmi 2 could be chosen from:

1. A strictly *vertical* suspension for ophthalmology (surgery of the anterior eye) had no separate fine focusing mechanism but used the slow motion of 5mm/sec of the motor stand for focusing. The suspension was such that the microscope's optical axis corresponded to the mechanical axis of rotation. As light sources served the usual homogeneous and/or slit illuminator, mounted on a carrier ring on the microscope body so that they could be oriented at will and aimed at the operating field for objectives of $f = 150 - 200\text{mm}$ (Fig.40).
2. An *angled* suspension at 45° for vertical or horizontal orientation as required for ear or hand surgery. This version had its own motorized fine focusing mechanism while the motor stand moved with 15mm/sec vertically.
3. More flexible still was the *cardanic* suspension: the microscope could be tilted and rotated in the three spatial axes. This model was preferred by neurosurgeons (Fig. 41).

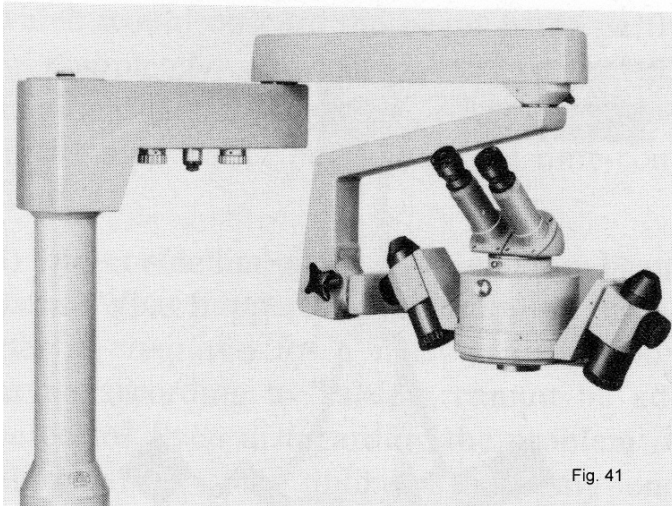

Opmi 2 with cardanic suspension and two focusable low voltage illuminators

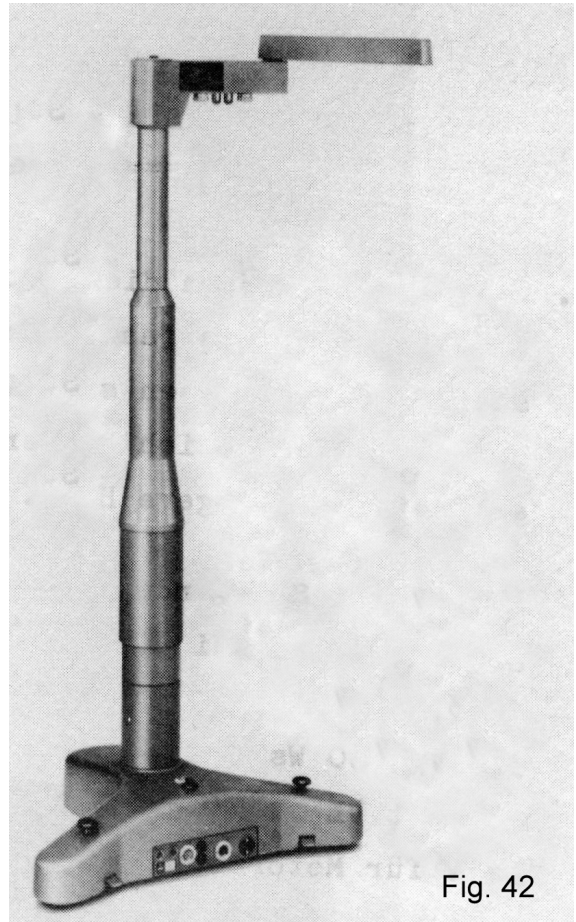

The motor stand (w/o microscope attached)

For many cases the two coaxial light sources, necessary for viewing deep cavities, were inadequate when working on open surfaces. Two external 6 v 15 W focusable illuminators provided additional light for such cases.

For controlling the motorized functions of microscope and mount the operator used a foot control panel, at first one for both feet, later on a compact single-foot panel. An optional motorized operating chair with arm rests and integrated foot controls for chair and microscope offered the ultimate comfort.

Motorized Floor Stand and Ceiling Mount

The **Opmi 2** was offered immediately with a new Motor Stand (Fig. 42) having a vertical speed of either 5mm/sec or 15mm sec., the latter for microscopes with their own motorized fine focus. For cases that

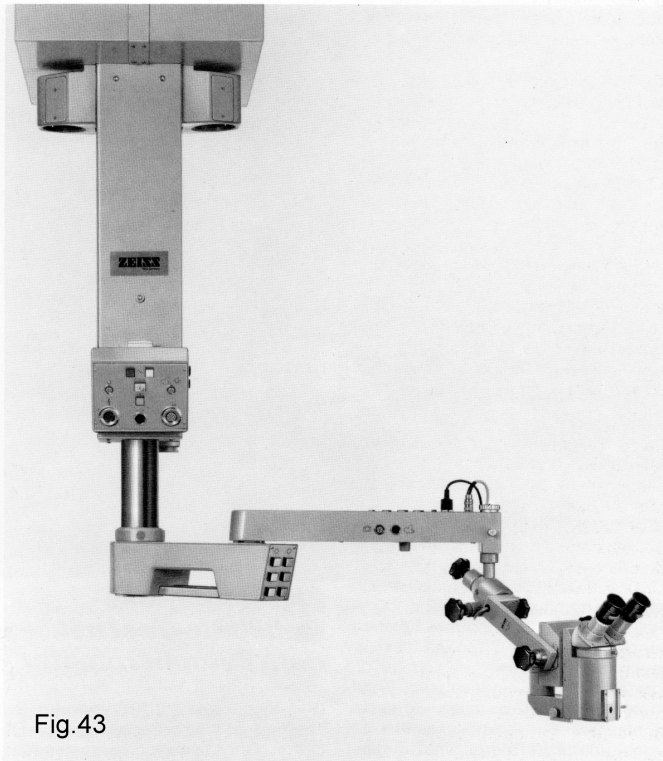

Fig.43

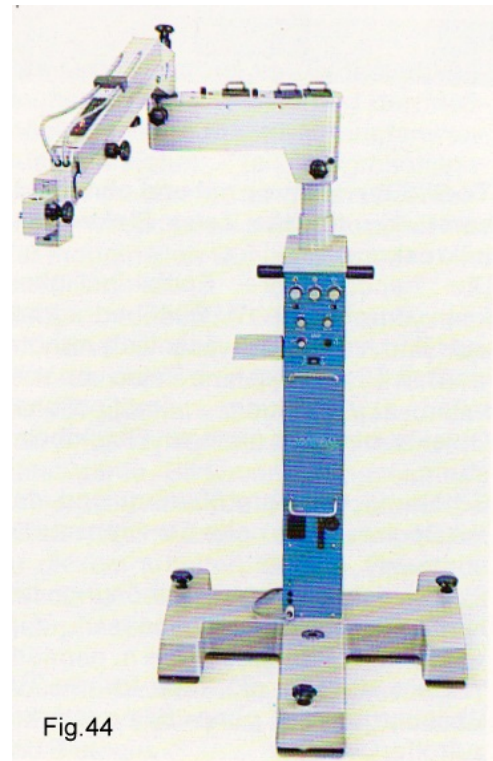

Fig.44

demanded additional height or frequent rapid height changes there was a version with a hand-crank extension of 390mm. The articulated arms had internal wiring, extra couplings could be used for extensions or special configurations.

At that time (ca. 1977) the electro-hydraulic ceiling mount was also replaced by an electro-mechanical one with articulated arms identical to those of the motor stand (Fig.43). A new feature of this stand was that it could also be mounted on a motorized track to be moved aside or outside the operating room. It must be mentioned here that all ceiling mounts depended on a safe and vibration-free ceiling structure and their installation often involved considerable engineering on the part of the hospital.

With the arrival of the Opmi 6 series (see below), all stands were totally reconfigured. I mentioned earlier that Wild-Leitz entered the market with their own operating microscope in 1981. In contrast to the Zeiss floor stands with their articulated horizontal arms, the Wild floor stand featured a novel parallelogram arm for easy vertical height adjustment. Zeiss adopted this idea and brought out their own new version of floor stands **Universal 2 and 3** with their distinctive blue front (Fig.44). These new stands replaced all existing stands (except those for the Opmi 9 and 99).

Two power inserts served either a purely manual microscope or a motorized one. The light sources for two fiber optics illuminators were incorporated in the first horizontal arm, the fibre guides hidden inside the parallelogram arm, as was all wiring for the motorized controls.

The spring tension of the arm accommodated a wide range of Opmi configurations. The heavy base ran on five castors and was dimensioned not to interfere unduly with the operating tables.

The surgeon controlled all motorized functions with a single-foot panel or a correspondingly equipped operating chair. As of 1985 he could also choose a voice control system, which after the initial excitement soon fell out of favour.

For ophthalmic surgery a compact combination floorstand cum operating chair offered maximum comfort (Fig.45). The stand column was arranged behind the surgeon, its arm reaching over his head or shoulder. A rather whimsical poster which enjoyed great popularity especially among the nurses showed a surgeon in

Electromechanical Ceiling Mount, with Opmi 6. Power supply for motorized microscopes and several light sources are included. At the top two brackets for optional operating lamps.

Floor Stand Universal S 3 for motorized microscopes, couplings, and several illuminators. The simpler S 2 accommodated manual microscopes.

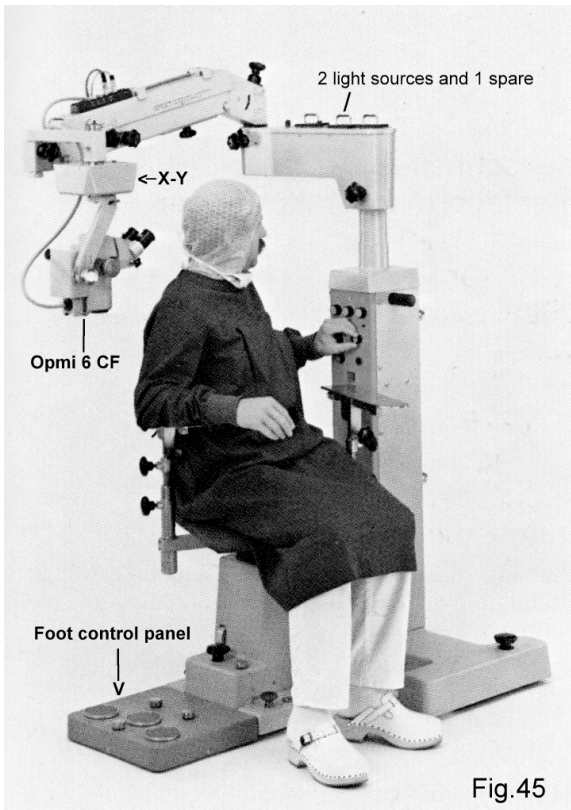

Fig.45

Universal Chair Stand S 3B, an op-chair./microscope combination.
 In this case equipped with Opmi 6CF (short version, with integrated beam splitter and fibre illumination) on X-Y coupling. Note the tiltable inclined binocular tube.
 The chair was fitted with adjustable arm rests.

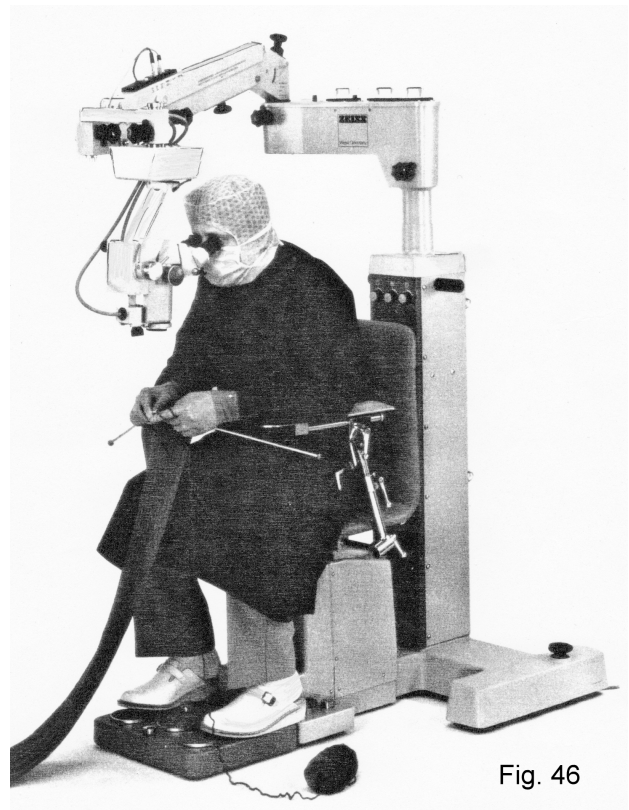

Fig. 46

The famous "knitting surgeon", with Opmi 6 SF, X-Y coupling, beam splitter, and tiltable tube

greens sitting in the chair knitting a long scarf! I can show only a poor Xerox-copy of this poster for you to enjoy (Fig.46).

The new generation ceiling mounts **S 2** and **S 3** corresponded to the floor stands Universal 2 and 3 and were based on the same design and featured the same parallelogramme arm (Fig. 47).

The Opmi 6 and 6S

Understandably, the motorized zoom operating microscope Opmi 2 was considered a great improvement and hospitals rushed to acquire it. However, it soon became apparent that its bulky dimension was rather detrimental to its safe use, as it tended to obstruct the surgical instruments and the visibility of the operating area by assisting personnel. Responding to this criticism Zeiss replaced it in 1972 by the Opmi 6 .
 The **Opmi 6** (Fig.48) had the basic dimensions of the Opmi 1, a narrow cylindrical body 70mm in diameter but also 130mm long. It featured the same coaxial 6V 30W illuminator, but had motorized fine focus, geared N-S tilt on a single lateral arm, and a zoom range of 1:5 (Fig.49). For an E-W tilt a geared angled coupling could be employed. The same motorized floor stand served as suspension. There was also a purely manual version of the Opmi 6.

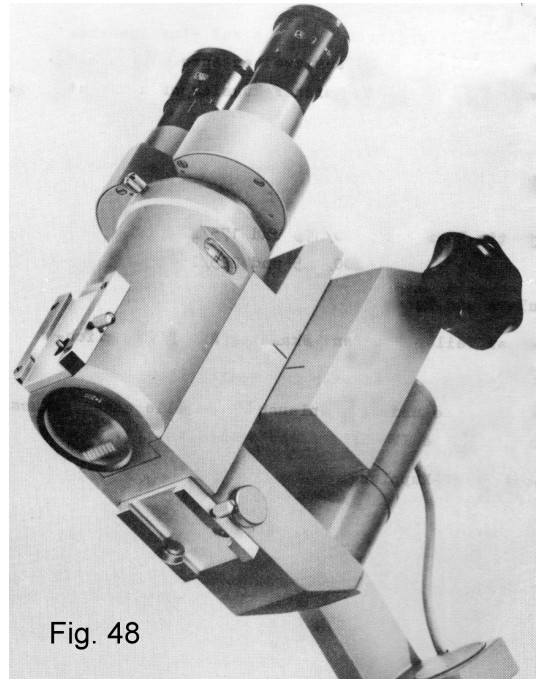
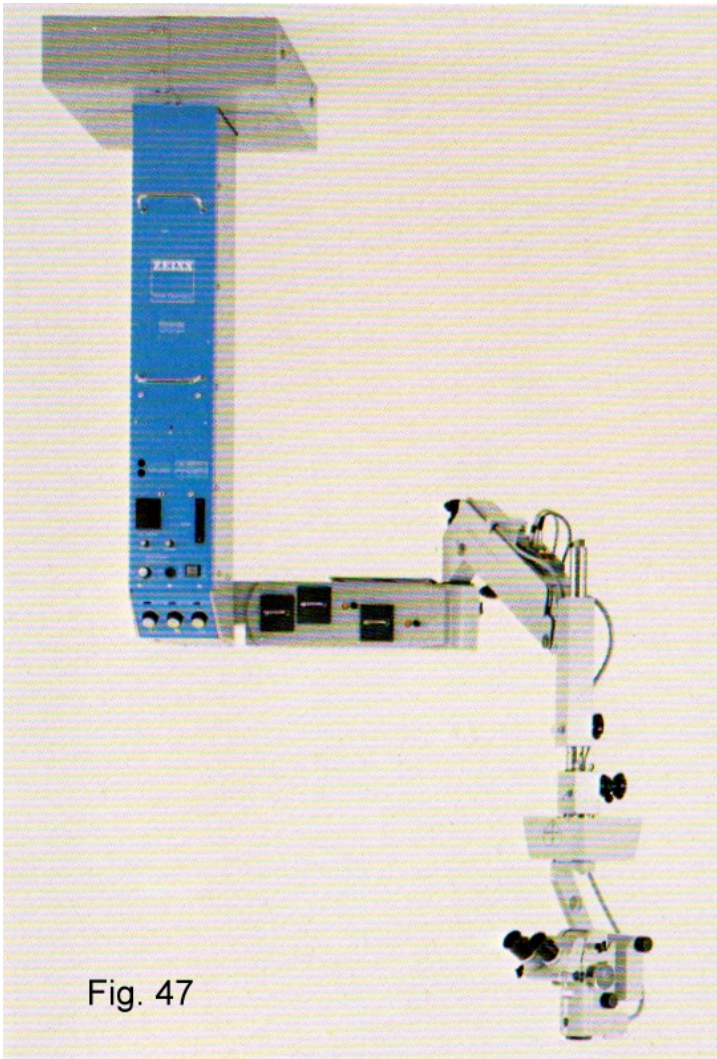

Opmi 6 with motorized zoom 1:5 and motorized fine focus. Note reflexion of lamp filament on objective

Fig. 47
Ceiling mount S 3 equivalent to Floor Stand Universal S 3. The main column is stationary, up and down movement is by the parallelogram arm. The long coupling above the X-Y coupling allows the overall vertical range to be extended if so desired

Similar to the Standard Microscope series so well known to the readers, the Opmi series was also largely standardized so far as basic features and accessories were concerned. In a hospital using several Zeiss operating microscopes accessories could be economically shared. This fact made it also easy for the users to upgrade their Opmi 2 without undue expense to an Opmi 6 while retaining the stand, the binocular tubes, objectives, and various accessories (This also meant that suddenly a number of Opmi 2 bodies ended up on the scrap heap and were eagerly picked up by hobby microscopists and tinkerers such as me. I shall describe my Opmi 2 at a later date).

The Opmi 6 body was now slim, but still too long, particularly if a beam splitter had to be interposed, hence the new **Opmi 6S (short)**. The reduced length of 90mm was achieved at the expense of a smaller zoom range of 1:4. At around this time Zeiss began also to offer a tiltable binocular tube $f = 160\text{mm}$ with screwed-in eyepieces. From straight to inclined this tube covered an angle of 60° , but almost more important, in the lowest, 45° position, the eyepieces were in effect ca 100mm lower (and somewhat forward off-set) than with the regular inclined tube. This made the effective eye to surgical field distance much shorter and provided a more comfortable position for the surgeon when such accessories as a beam splitter had been attached. A special version of the Opmi 6S, the **Opmi CS**, had a built-in beam splitter for more compactness (Fig.50).

The **Opmi 7** is the ophthalmic version of the Opmi 6, mounted strictly vertical with the rotational axis coaxial with the optical axis without fine focus or internal illumination. A motor stand with 5mm/sec vertical movement served to focus. For surgery of the anterior eye a homogeneous and a slit illuminator provided illumination. Suitable objectives were from $f = 150$ to $f = 200\text{mm}$. To meet the need of the surgeon to reorient the instrument over the eye, Zeiss offered an X-Y coupling with a motorized lateral movement of $\pm 25\text{mm}$ in two directions controlled by a joy stick (See Figs. 45 and 47).

Opmi 6 S (short) with integrated beam splitter and tiltable binocular tube. The oblong black plug in front hides a thread for an accessory dovetail



Fig. 49

The zoom system of the Opmi 6. The system has one fixed upper lens pair and two movable lower ones. The cam controls the movement of the bottom lens pair

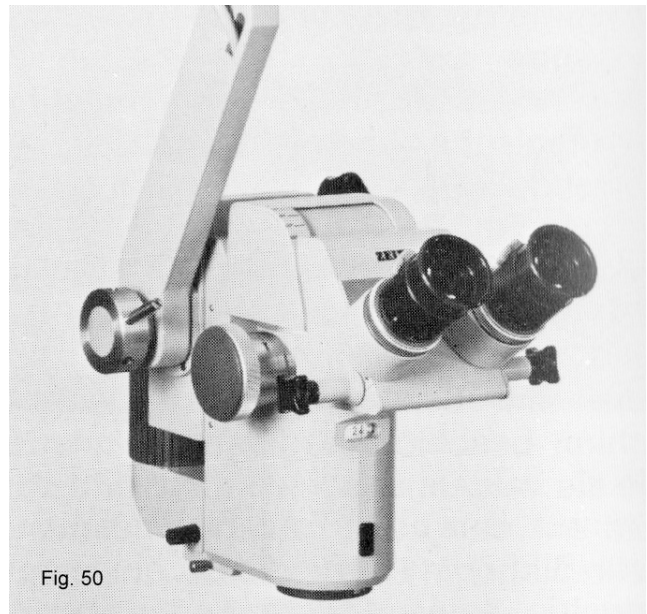

Fig. 50

The Stereo Beam Splitter

The **Stereo Beam Splitter** was intended to convert a single Opmi into a double one (similar to the Diploscope) for two opposing surgeons. It required, however, a

reorientation of the two optical systems in the microscope body by 90°. This, in turn, made any lateral suspension arm impossible, hence only the Opmi 7 model with its vertical suspension and no built-in illuminator or the Opmi 2 with cardanic suspension were suitable. Two straight binocular tubes were usually used in conjunction with the stereo beam splitter, unless the microscope was considerably tilted (via a tilt coupling), in which case two inclined tubes were necessary.

The final version of the stereo beam splitter had one lateral central port for such accessories as additional observer tube or photographic/cine/video attachments without increasing the overall length of the microscope.

This special version of the Opmi was called **Opmi 7D** (Fig.51 left). As light source served two lateral fibre optics illuminators fed from a power supply unit mounted on top of the motor stand. Focusing was provided by the motor stand's height adjustment. If the Opmi 7D was used in eye surgery and fitted with the additional XY-coupling, the motorstand had to be extended in height either by an extension piece (300mm) or by choosing the version with manual crank extension. With all these options it was the sales representative's job to analyse carefully the customer's needs and propose the most suitable and economical configuration.

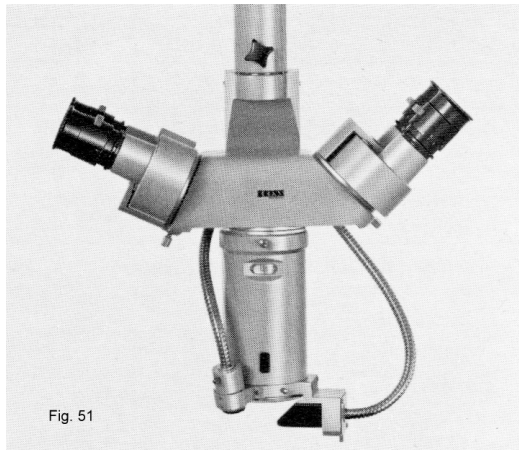
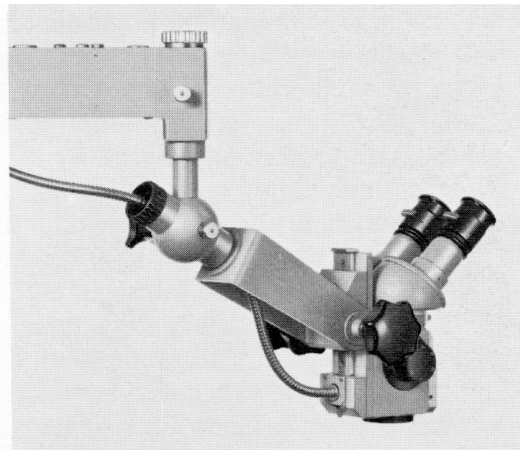

Fig. 51



Opmi 7 D (without built-in illuminator and focusing mechanism), shown with stereo beam splitter and an oblique and a co-axial fibre illuminator (left). Its Galilean system is turned by 90°. The Opmi 7 is the same but with the Galilean system in the normal position .Right: Opmi 1 F with co-axial fibre illuminator

The **Opmi 8** consisted of an Opmi 7 with two solid arms on its coupling shaft. One arm carried an illuminator, homogeneous or slit, the other a second microscope body at 27° to the main axis, oriented either to the left or right of the main surgeon.. This second microscope body also contained a motorized zoom

system like the Opmi 7 proper. If needed, a second illuminator could be mounted on a carrier ring of the objective.

The last of this generation of Zeiss operating microscopes is the **Opmi 9** (Fig.53). As a simple and inexpensive instrument it was mainly aimed at the doctor's office, teaching labs or veterinarians. The Opmi 9 had no focusing device or initial magnification changer. Focusing was accomplished by moving it on its parallelogram suspension arm, but a simple focusing device $\pm 12\text{mm}$ for the objective could be attached. A 3-step magnification changer was optional. As light source served the well known 6V 30W coaxial illuminator from the Opmi 1. Besides a simple floor stand, a table mount, a wall mount, or a simple ceiling column were offered.

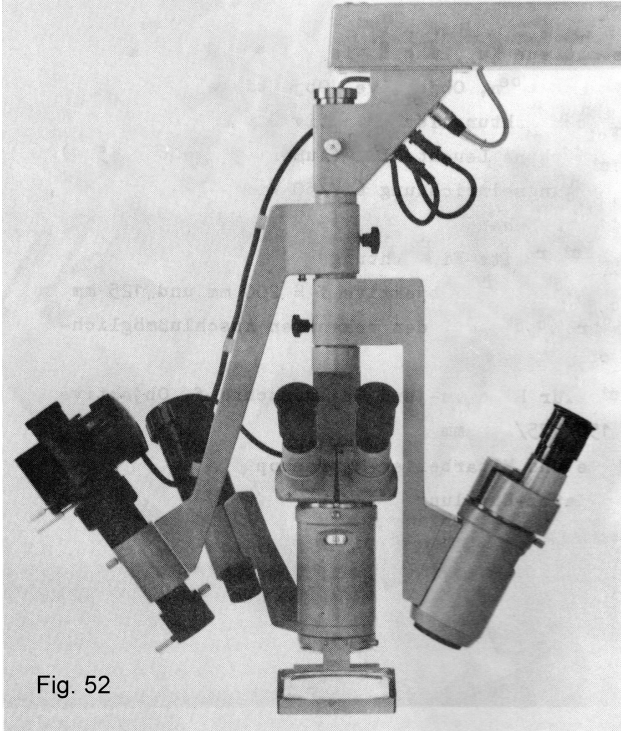

Fig. 52

Opmi 8, identical to the Opmi 7 but with an additional microscope body attached. The second illuminator is mounted on an objective with double carrier ring, same as the operating magnifier. All are individually rotatable. The slit lamp has an optional prism in front for lateral displacement of the slit.

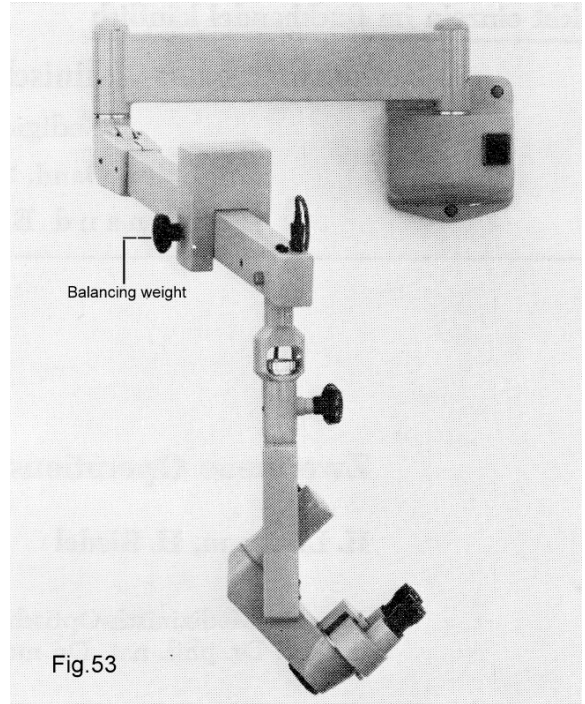

Fig.53

Fig. 53
Basic Opmi9 on wall mount

Assistant's microscopes

Microsurgery is very demanding and requires much training. There existed, therefore, a great need for possibilities to involve a second surgeon for training or assistance. This explains the many models of Opmis set up for two or more surgeons. Many surgeons owning older instruments expressed a wish to add an assistant's microscope to their instrument. To accommodate these wishes, Zeiss offered several options:

The assistant's microscope 27°

In order to attach minor accessories, the most common objectives $f = 150\text{mm}$, $f = 175\text{mm}$, and $f = 200\text{mm}$ could be had in a special carrier ring onto which such accessories as operating magnifier, illuminators, or assistant's microscopes could be attached and rotated from left to right.

The assistant's microscope 27° consisted of an objective with a focal length of 25mm longer than the main objective and a straight binocular tube. A 3-step magnification changer was optional as was a simple focusing device. This set-up was adequate for surgery in exposed areas, but not for deeper cavities (Fig. 54).

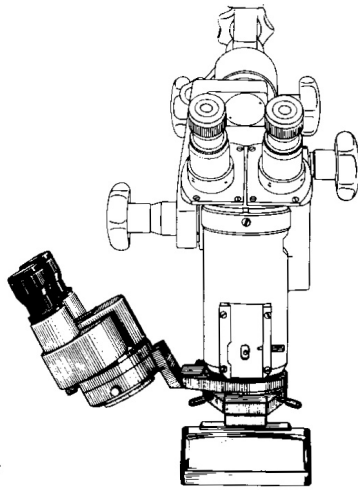

Fig. 54

Assistant's Microscope 27° and operating magnifier on Opmi

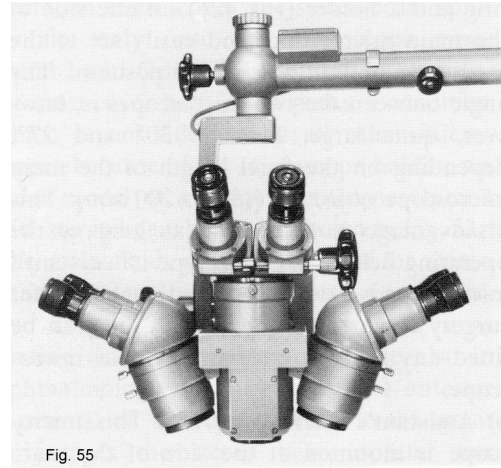

Fig. 55

Assistant's Microscopes 18° on Opmi 6.

The assistant's microscope 18°

A special carrier secured to the front of the microscope body held one or two simple microscope bodies without magnification changer (optional), and with an inclined binocular tube. These microscopes were arranged at fixed right angles to the main surgeon and as with the 27° model were compatible with main objectives $f = 150 - 200\text{mm}$ (Fig. 55).

The assistant's microscope 8°

With almost the same angle of observation as the main microscope this accessory was also suitable for work in narrow cavities. It too was mounted on an objective carrier ring and could be oriented left or right as desired. It had its own manual $\pm 6.5\text{mm}$ focusing device and optional 3-step magnification changer (Fig.56).

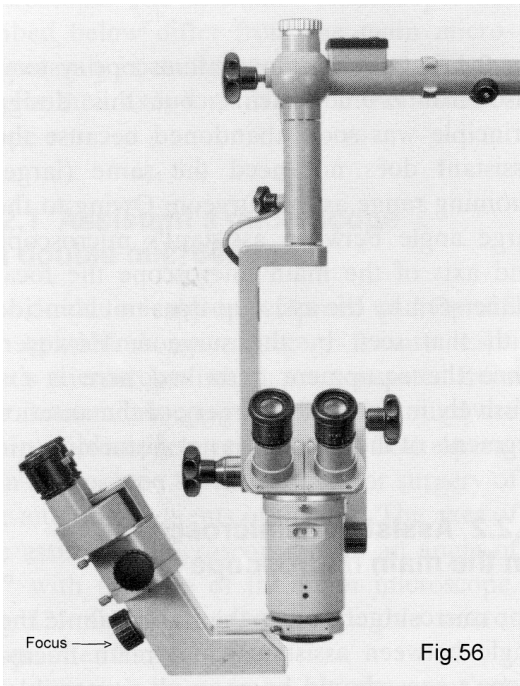

Fig.56

Assistant's Microscope 8° with optional 3-step magnification changer on Opmi 6S.

The Opmi 99

There is now but one instrument that is still worth mentioning, the "economy **Opmi 99**" (Fig.57).

Intended for the private market where cost is of higher importance the Opmi 99 is a miniaturized version of the standard operating microscope. It is of a simple design, utilizing to a great extent “engineering polymers” (as plastics are euphemistically called), carbon fibre reinforced polymers for the small straight or inclined binocular tubes $f = 80\text{mm}$ with fixed high-eye point eyepieces 19x.. The Galilean 3-step magnification changer 0.6 – 1 – 1.6x has a base of 16mm. There are 5 objectives $f = 100$, $f = 200$, $f = 250$, $f = 300$, and $f = 400\text{mm}$ giving a range of magnifications from 2x to 48x depending on the configuration. The objective mount has a 10mm fine focusing device, beyond that the entire instrument can be moved on its balanced parallelogram arm.

There are three stands: a short stand for the colposcope version (Fig. 58), a tall floor stand for the doctor’s office and electrologist, and a table stand for lab work. The floor stands consist of a heavy weight on a frame of five castors. The fibre light source is integrated into the main arm of the stand.

There are no special accessories for the Opmi 99. It found particular application for electrolysis (hair removal) as improved visualization resulted in faster, more efficient and safer work.

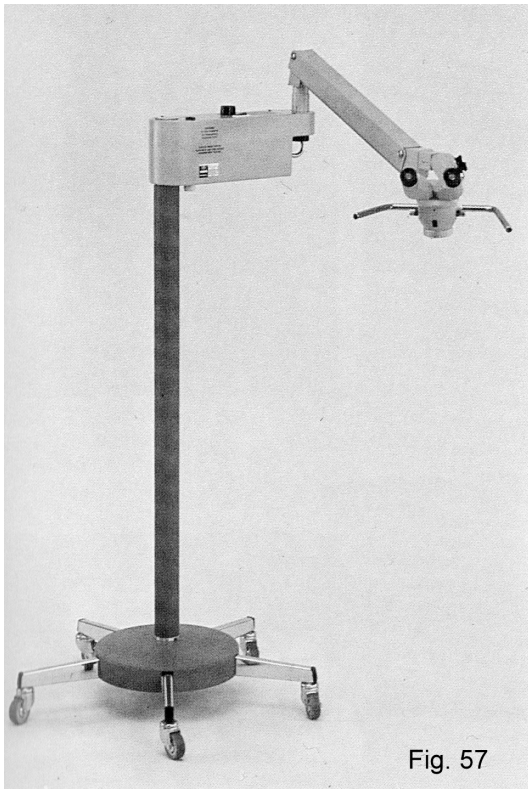

Fig. 57

Opmi 99 on floor stand. The double handle could be covered with sterilizable sleeves

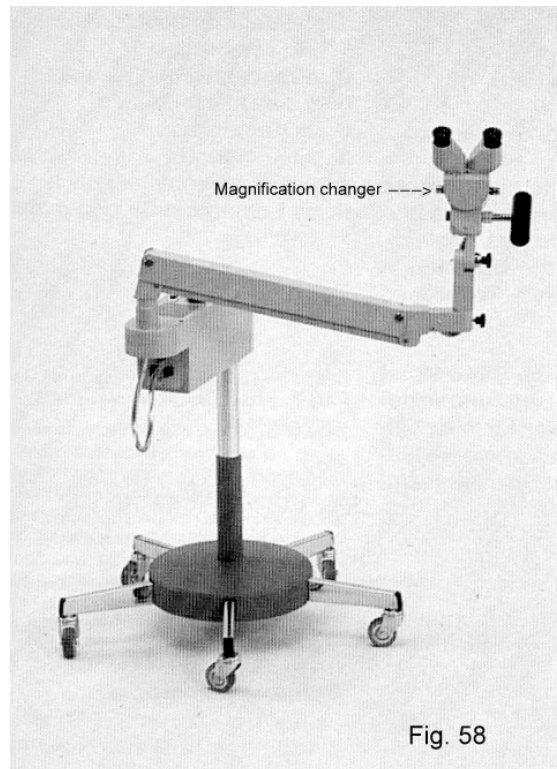

Fig. 58

Opmi 99 as Colposcope. The magnification changer came with small sterilizable caps for easier hold. The single handle served for all motions including tilting.

Outlook

We have now reached the mid 1980s and this is a proper time to stop. From now on the development of the Zeiss Operating Microscope is almost exponential, the designs of both microscopes and stands being radically different and quite often industrial designers were involved as exemplified by the two examples given (Figs.59 and 60). Rather than being of a “building block” system, the new microscopes are bespoke designed for a specific purpose e.g. neurosurgery, plastic and reconstructive surgery, dental surgery, ophthalmic surgery, and so on, with miniaturized integrated imaging systems. The CO_2 laser became an attachment to the Opmi, video-imaging via computers assists the surgeon, stereo-tactic navigating systems help the neurosurgeon in brain surgery, there is even talk of robotic microsurgery. As I said in the beginning, we couldn’t do today without the operating microscope. We may well spend some time learning about it as it is quite likely that one day we shall benefit from it ourselves.

* * * * *

Fritz Schulze
Vineland, ON, Canada
Glenelly@sympatico.ca

November 2012

Published in the January 2013 issue of Micscape Magazine,

URL: <http://www.microscopy-uk.org.uk/mag/artjan13/fs-Operating-Microscopes-2.pdf>

Part 1 published in the December 2012 issue.

URL: <http://www.microscopy-uk.org.uk/mag/artdec12/fs-Operating-Microscopes-1.pdf>



Bild 1:
Das System OPMI®
Vario/NC 33 wurde exklusiv für minimal invasive Eingriffe im Bereich der Wirbelsäule entwickelt.

Fig.60

Fig. 60
Opmi VARIO/NC 33 for minimally invasive surgery, especially the spine. A modern version of the "Contraves" mobile stand (Compare with Fig. 31). 1998



Fig. 59

Fig. 59
Opmi VISU 200 for ophthalmic surgery (1998) with 2° and 6° coaxial illumination and with 0° assistant's microscope and x-y coupling. All settings for brightness, magnification, motor speed etc. can be stored and recalled. Automatic lamp change in case of failure.